

CAT8 RJ45 Tool Less Shielded Plug

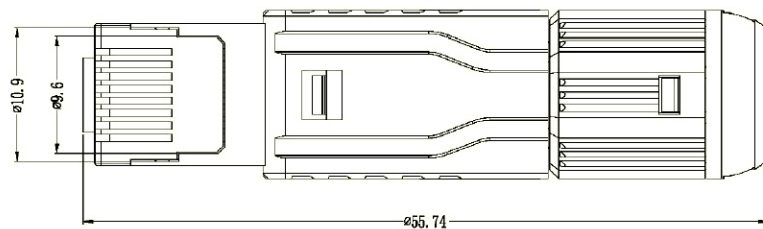
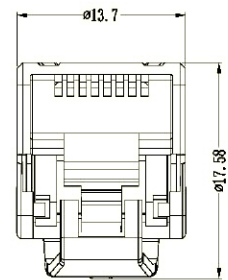
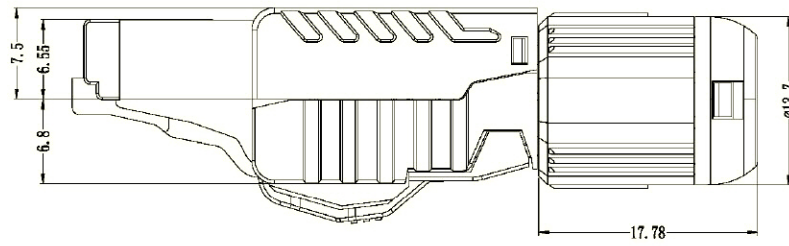
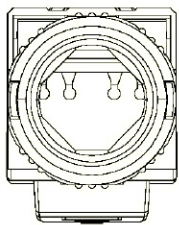
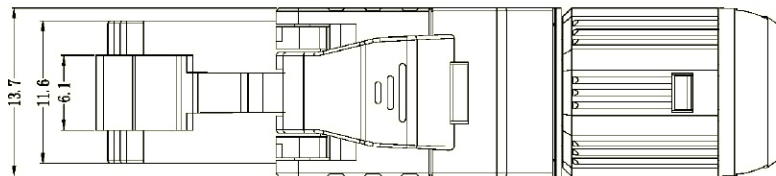
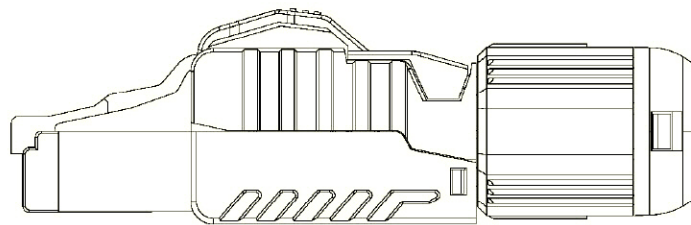
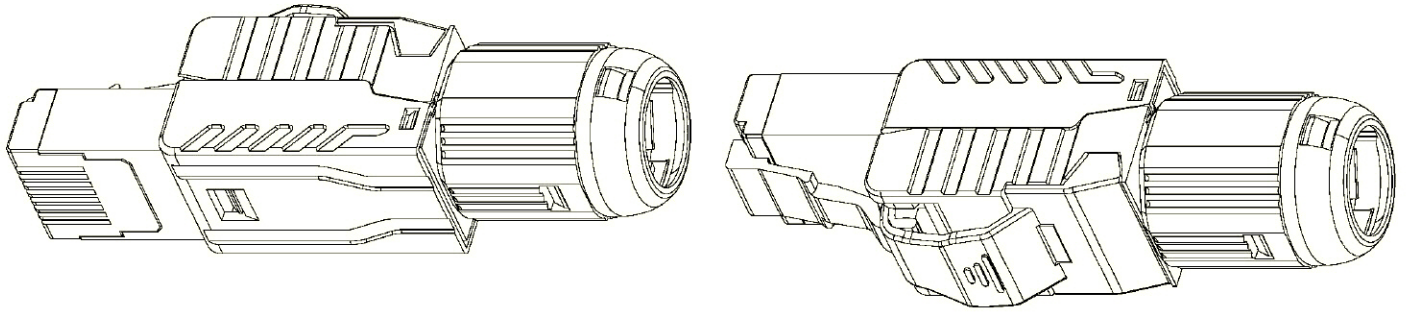

CAT8 RJ45 Tool Less Shielded Plug

SPECIFICATION DESCRIPTION

<i>MATERIAL</i>	
SHIELD CONTACT	NICKEL SILVER ALLOY
PLUG HOUSING	ZINC ALLOY, NICKEL PLATED
CONTACT HOLDER	PC, UL94V-0
PLUG CONTACTS	PHOSPHOR BRONZE, 60U" GOLD PLATED ON CONTACT AREA
INTERFACE	RJ45
<i>PHYSICAL CHARACTERISTICS</i>	
INSERTION LIFE	750 MATING CYCLES
PLUG RETENTION FORCE	11 LBF MINIMUM
INSERTION FORCE	30 N MAXIMUM
RE-TERMINATION	UP TO 20 TIMES
CONTACT COMPATIBILITY	ACCOMMODATES 22 TO 26 AWG SOLID OR STRANDED
CABLE JACKET DIAMETER	6.5 mm TO 8.5 mm
OPERATING TEMPERATURE RANGE	-10°C TO 60°C
STORAGE TEMPERATURE RANGE	-40°C TO 68°C
HUMIDITY	10% TO 90% RH (NON-CONDENSING)
<i>ELECTRICAL</i>	
DC CURRENT RATING	1.5 Amps
INSULATION RESISTANCE	500M Ω MINIMUM
INPUT TO OUTPUT D.C RESISTANCE FOR SHIELD	100m Ω MAXIMUM
INPUT TO OUTPUT D.C RESISTANCE	200m Ω MAXIMUM
CONTACT RESISTANCE	20m Ω MAXIMUM
VOLTAGE PROOF (CONTACT TO CONTACT)	1000 V D.C. OR A.C. PEAK
VOLTAGE PROOF (CONTACT TO SHIELD)	1500 V D.C

